

BONECO
healthy air

TRADITION SINCE 1956
 A SWISS COMPANY



Spare-Parts
Air Washer W2055A

Contents

Topic	Page
Dismount instructions	03
Exploded - View	05
Spare Parts	06

Dismount instructions



W 2055A



Remove the tank



Take top of tub



Upper part tub, tank, disc



Loosen cover on both sides



Remove the fan blade

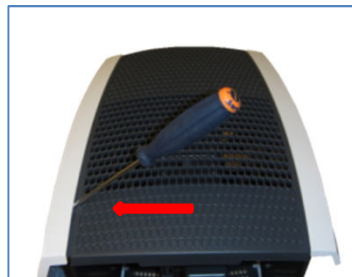

Loosen front on both sides



Front ,cover, fan blade



Print solve housing



Invert device and solve all 4 screws

Dismount instructions



Interior

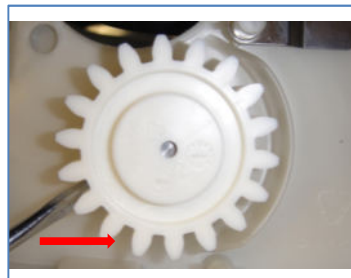

Remove gear assemblies holder

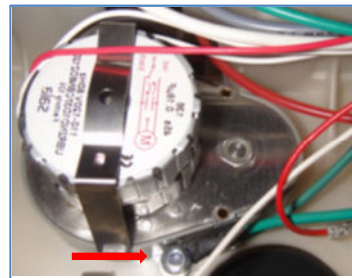

Gear motor with two screws solve

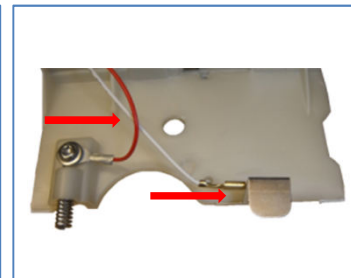

Remove contact spring and cable



Holder assemblies, gear, gear motor, fan motor, contact spring with cable

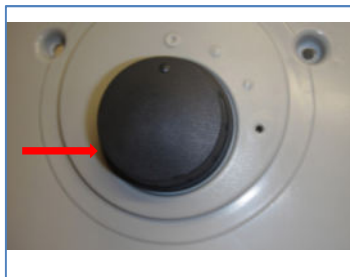

Remove switch button



Screwing off print

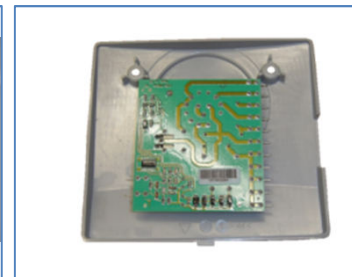

Take print from the housing

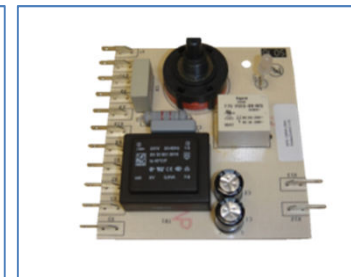

Print 2055A

Exploded - View

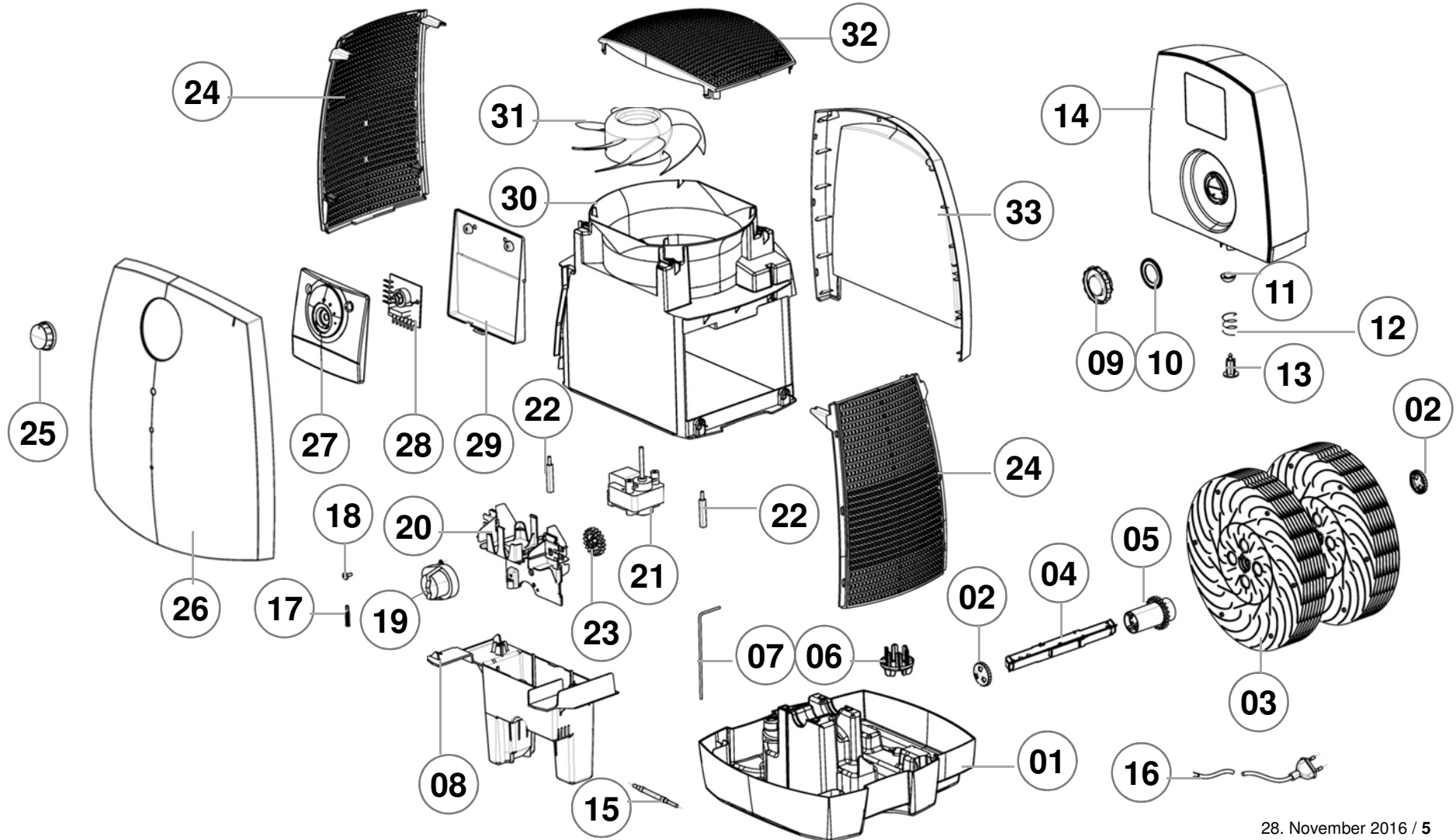

Spare Parts

Pos.	Item	Description	
01	33597	base grey W2055A	
02-05	33546	disc ass. comb structured W2055A	
02	24383	disc lock W2055	
03	n/a	disc W2055A	
04	24381	axle W2055A	
05	24382	axle gear W2055A	
06	32876	fragrance capsule key W2055A	
07	24534	grounding wire W2055A	
08	24379	enclosure gear motor grey W2055A	
09	22419	Tankverschluss ohne Dichtung W2055A	
10	23805	Gasket W2055A	
11	22229	tank membran W2055A	
12	22239	pressure spring W2055A	

ACC = Accessories N/A = not available, prices see separate price list

Spare Parts

Pos.	Item	Description	
13	22420	tank tappet W2055A	
14	24668	water tank W2055A	
15	Acc	Ionic Silver Stick ISS A7017	
16	n/a	power cord W2055A	
17	n/a	spring for grounding W2055A	
18	n/a	screw gear motor W2055A	
19	24484	gear motor W2055A	
20	n/a	motor carrier W2055A	
21	24481	fan motor W2055A	
22	n/a	brush W2055A	
23	18319	sprocket for gear motor W2055A	
24	24372	grid W2055A	
25	24384	knob W2055A	

ACC = Accessories N/A = not available, prices see separate price list

Spare Parts

Pos.	Item	Description	
26	24370	front cover white Boneco	
27	n/a	enclosure PCB grey W2055A (front)	
28	32993	main PCB W2055A	
29	24377	enclosure PCB grey W2055A (back)	
30	n/a	middle part W2055A	
31	24376	fan blade W2055A	
32	24373	top W2055A	
33	24371	rear cover white W2055A	

ACC = Accessories N/A = not available, prices see separate price list